

USER MANUAL



Thank you for choosing Better Bathrooms.
Please read this manual before installing your product
and keep for future reference.

**better
bathrooms**

Outdoor shower Tower Brushed Steel BeBa_28530

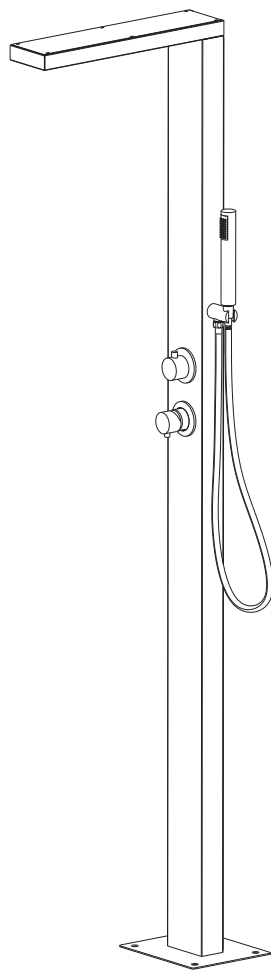

Please note: Image is for illustrative purposes only and may differ slightly to the actual product

- **Multi person assembly**
- **Tools required**
- **We always recommend using professional**
- **tradespeople to install your product**

V1_08.04.22

Congratulations on your purchase

And welcome to our growing gang of savvy shoppers

We're on a mission to bring you extraordinary bathroom products, for less. From modern to traditional style ceramics, plus the gorgeous fixtures, fittings and furniture to match. So, you can fall in love with your space every single day.

As one of the UK's largest independent bathroom stores, we've received countless awards; including the National Business Awards UK, the Digital Entrepreneur Awards and being placed on The Sunday Times Fast Track 100.

We hope your new product goes above and beyond your expectations. However, should any problems occur, please:

- log in to your account and contact our customer services team via your self-serve portal – betterbathrooms.com/CustomerAccount/Login
- contact us via betterbathrooms.com/content/contact-us

Important information

Please read these instructions thoroughly and retain for future reference

Minimum Working Pressure 1 bar

Maximum Working Pressure 3 bar

Pressure MUST be balanced

Hot supply MUST be connected to the left-hand inlet of the mixer

All installation work must be carried out to comply with:

The Water Supply (Water Fittings) Regulations and Water Supply (Water Fittings) (Scotland) Byelaws

The system must be thoroughly flushed prior to installation

Product must be checked for damage prior to installation

Always check the installation area before drilling for pipes and cables

Contents

- **Parts/ Diagrams-----4**
- **Tools required-----5**
- **Installation-----5**
- **Using-----10**
- **Troubleshooting-----10**
- **Cleaning-----11**

Tools required

Spanner

Silicone

Drill and drill bit

Spirit Level

Pencil

Tape Measure

Hammer

Screwdriver

Socket

Installation

Use the screwdriver to unscrew the screws at the back of shower tower body and take out the back cover.

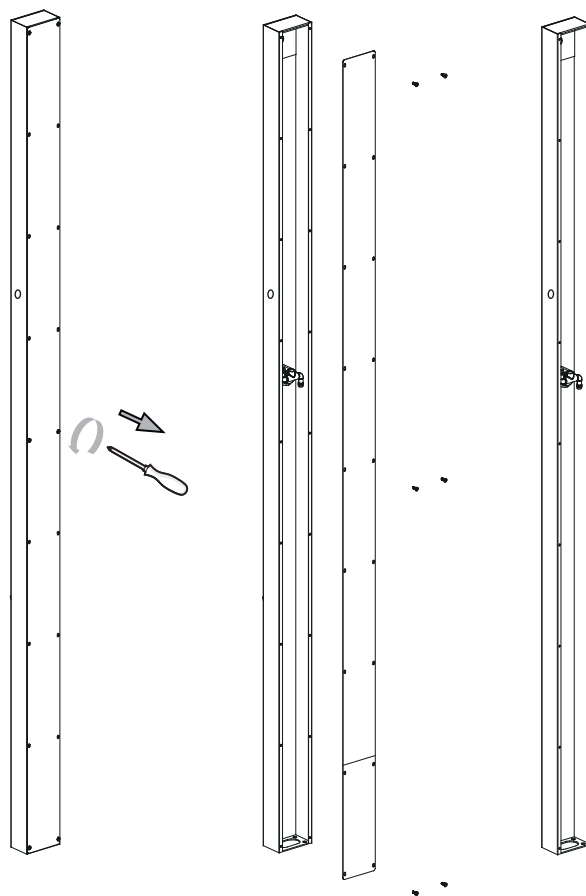

Use the screwdriver to unscrew the screws at the back of shower tower body and take out the back cover 1 and back cover 2.

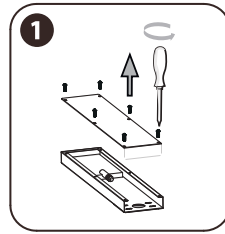

Use the screwdriver to unscrew the screws on overhead shower and take out the top cover.

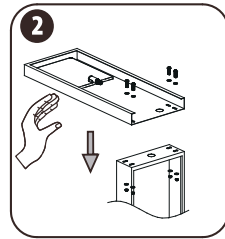

Fix the overhead shower onto shower tower body and tighten with the screws at one end by screwdriver.

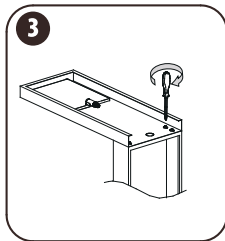

Pull out the pvc hose from the shower tower body and insert into the overhead shower.

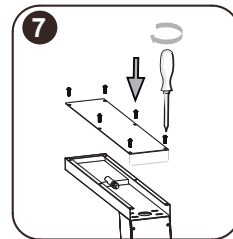

Take 1pc clamp and fix the pvc hose onto shower head.

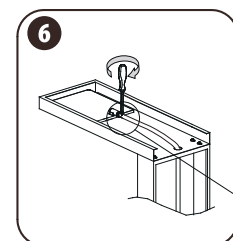

Use the screwdriver to tighten the screw on the clamp.

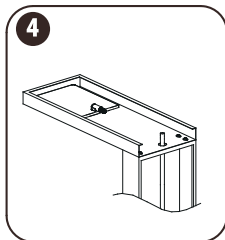

Put back the top cover onto overhead shower and use the screwdriver to tighten the screws.

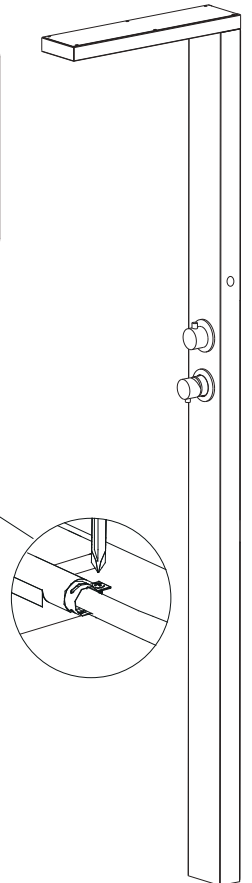
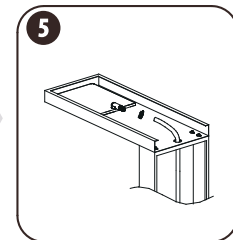

Put the base on the ground and use the pencil to mark the position.

Use the drill to drill the hole on the ground.

Insert the plugs into the hole with hammer.

Put the shower tower onto the base.

Tighten the nuts by socket.

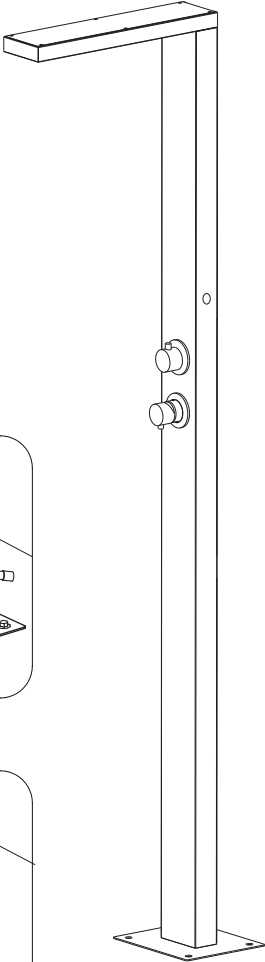
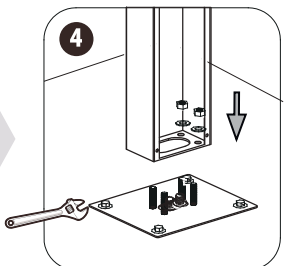
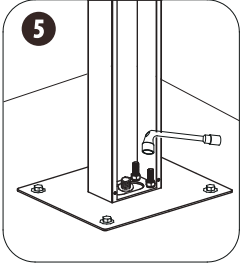
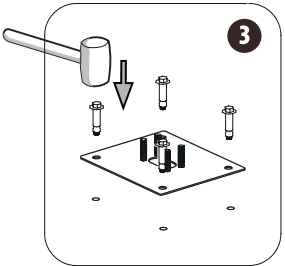
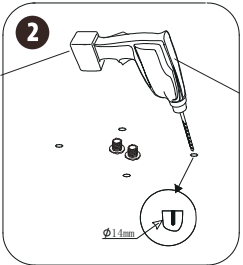
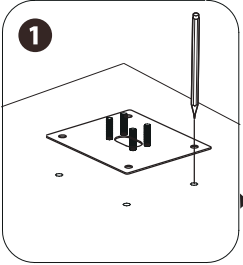

Connect the water-in hoses to the water supply and tighten with spanner.

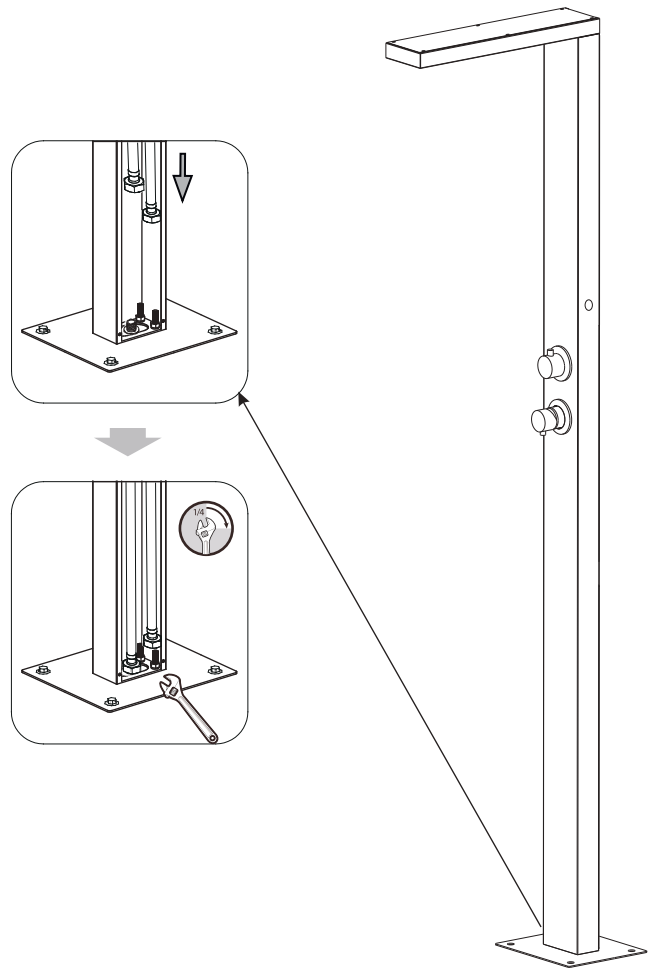

Insert the handshower holder into the hole on the body.

Put the white gasket at inner side of the holder , fix the nut to the holder onto the body. Use the spanner to tighten.

Pull out the hose on the shower tower, fit the seal into the connector, then fix the connector onto the holder and tighten by spanner.

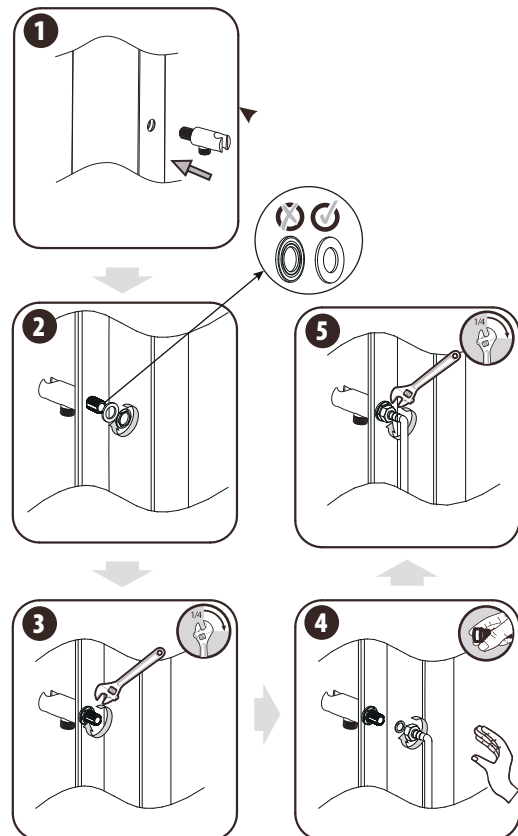

Fit the seal into the nut end of the shower hose and connect the nut to the outlet on the hand shower holder and tighten, if using a spanner, place a cloth around the nut to prevent damage.

Place the second seal into the cone end of the shower hose and connect this to the hand shower and tighten.

Place the cone of the hose into the holder.

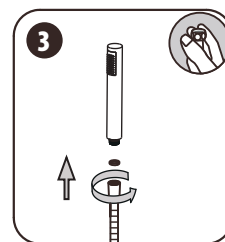
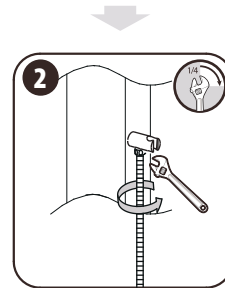
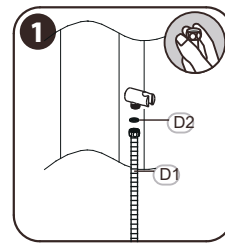

Turn on the water supply and check for leaks, if no problem, put back the back cover 1 and back cover 2 onto the body and tighten the screws.

Installation is then complete.

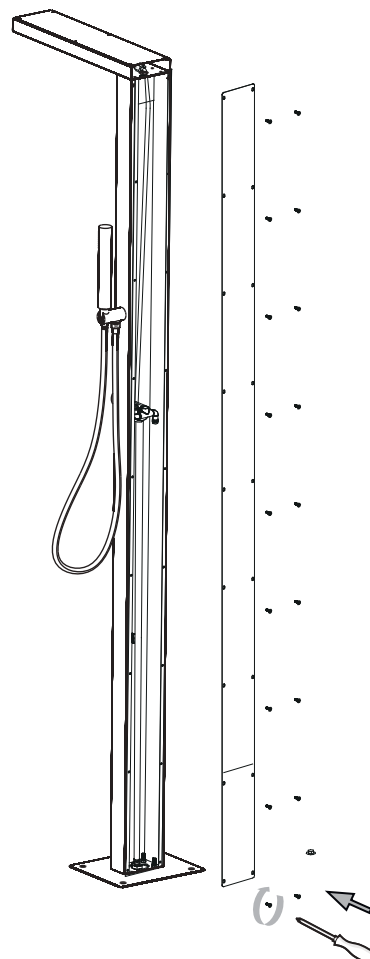

Using

To control the temperature, turn the temperature control handle until the desired temperature is reached.

To avoid freezing in winter, it's suggested to keep the shower tower in door.

For the least, unscrew the water supply pipe and turn on the mixer, let the water inside the pipe flow out. After the inner water all come out, turn off the mixer.

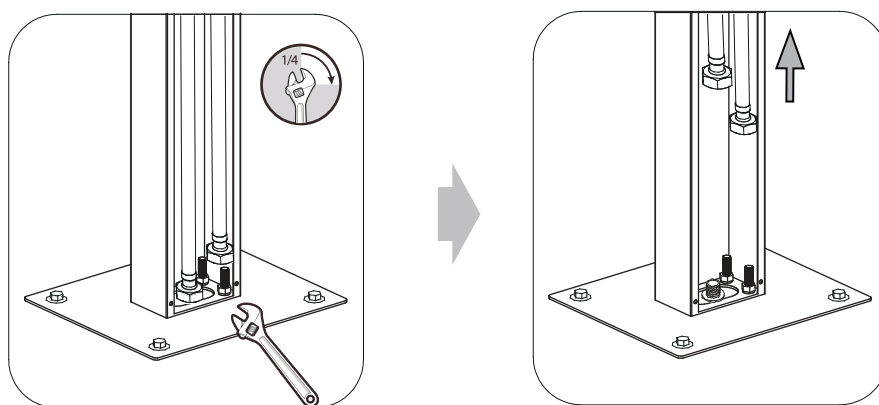

Troubleshooting

Water dripping after being turned off

1. Does the water stop dripping after a period of time, if so this is normal as the water within the unit needs to drain away, so some dripping may occur
2. Does the dripping continue, if so the flow control valve for the function that is dripping, will need to be replaced.

Cleaning

To maintain the surface of your product, wipe with a clean damp cloth and wipe dry, do not use any abrasive cleaning agents or materials .

It is recommended to wipe and dry on a regular basis.

For more information

- visit betterbathrooms.com
- email customerservices@buyitdirect.co.uk
- call 0330 390 3062
- write to Trident Business Park, Neptune Way, Huddersfield, HD2 1UA

better 
bathrooms

Part of the BuyItDirect Group